



# ACCESSORIES AND PARTS

UTG® A VAST SELECTION FOR YOUR ONE STOP SHOPPING NEEDS

## INTRODUCTION

Just like all of our other categories of products, Leapers UTG® continuously strives to provide a comprehensive selection of firearms accessories and parts. Trust in us to continue to listen to our customer's suggestions and feedback and devote our full energy, attention, and effort to developing what is asked of us from you, our loyal customers. We do not just offer parts and tools; every product incorporates the UTG® touch. Designed, developed, prototyped, and executed entirely in-house. If you find yourself here looking to accessorize and kit out your MSR from the ground up, you need not look any further. Our full lineup of products are always ready out of the box and come complete with everything you need to get up and gunning. Be sure to check out the new UTG PRO® USA Made flip-up sights and handguards, along with an extensive new series of M-LOK®, Keymod, and Picatinny foregrips, hand stops, and angled foregrips. Lastly, be sure to take a look at our new series of AR receiver components and polymer magazines.

**LEAPERS, INC.**  
**THE BEST NEVER REST**  
**LIFETIME WARRANTY**

## ABSOLUTE COMMITMENT TO QUALITY



Intensive Engineering and Programming



State of the Art Manufacturing

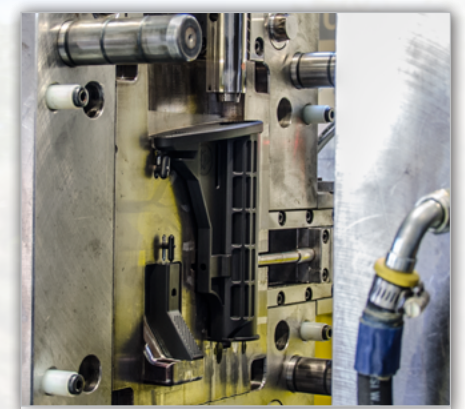

Optimized Fixture Design and Layout



Total Commitment to Precision



Relentless Search for Excellence



Best Valued Products on the Market

## NEW AND MUST HAVE PRODUCTS FOR 2019

<p><b>UTG PRO® PISTOL ACCESSORIES</b></p>	<p><b>UTG® POLYMER MAGAZINES</b></p>	<p><b>UTG® FOREGRIPS, HANDSTOPS, &amp; RESTS</b></p>	<p><b>UTG PRO® FLIP-UP SIGHTS</b></p>	<p><b>UTG® AR15 COMPONENTS &amp; SMALL PARTS</b></p>
---	--------------------------------------	--	---------------------------------------	--

- MADE IN USA
- PRECISION MACHINED
- 6061-T6 ALUMINUM
- +0 +0 CAPACITY

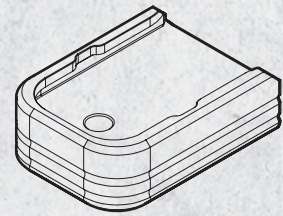

- AVAILABLE COLOR(S)
- MATTE BLACK ANODIZED
  - MATTE BLUE ANODIZED
  - MATTE RED ANODIZED
  - MATTE BRONZE ANODIZED

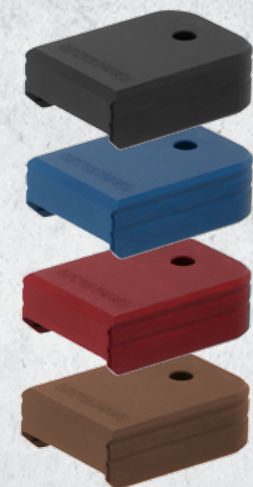

**UTG PRO® +0 Pistol Magazine Base Pads**

- Models Available for Some of the Most Popular Double Stack Pistols on the Market
- 0.347" Extended Height and 1 oz. Weight Helps Facilitate Faster Reloads with or without a Magwell
- IDPA & USPSA Legal



- Melted Contours and Dehorned Corners
- Added Weight Facilitates Faster Reloads
- Extended Height and Grip Serrations Improve Magazine Indexing

**+5 CAPACITY  
COMING SOON!!!  
- FOR SELECT MODELS -  
BASE PADS**

**IDPA/USPSA  
LEGAL**

**1oz.  
WEIGHT**



Item #	Black	PUBGL01	PUBGL02	PUBCZ01	PUBHK01	PUBSG01	PUBSI01	PUBSW01	PUBWR01
Make/Model		<b>Glock</b> Small Frame	<b>Glock</b> Large Frame	<b>CZ</b> • P07 • P10C 9/40	<b>HK</b> • VP9 • P30 9/40	<b>SIG</b> • P320 9/40 • P320 X5 (w/o mag well)	<b>SPRINGFIELD ARMOY</b> • XDm 9mm (with square magazine spring)	<b>SMITH &amp; WESSON</b> • M&P 9/40 (double stack only)	<b>WALTHER</b> • PPK 9/40
Capacity									+0
Weight									1 oz
Other Available Colors									
B=Blue	PUBGL01B	PUBGL02B	PUBCZ01B	PUBHK01B	PUBSG01B	PUBSI01B	PUBSW01B	PUBWR01B	
R=Red	PUBGL01R	PUBGL02R	PUBCZ01R	PUBHK01R	PUBSG01R	PUBSI01R	PUBSW01R	PUBWR01R	
Z=Bronze	PUBGL01Z	PUBGL02Z	PUBCZ01Z	PUBHK01Z	PUBSG01Z	PUBSI01Z	PUBSW01Z	PUBWR01Z	

- MADE IN USA
- PRECISION MACHINED
- 6061-T6 ALUMINUM

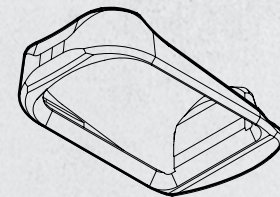
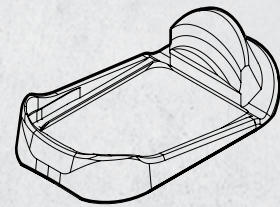

- AVAILABLE COLOR(S)
- MATTE BLACK ANODIZED
  - MATTE BLUE ANODIZED
  - MATTE RED ANODIZED



**UTG PRO® Ultra Slim Glock® Magwells**

- 6061-T6 Aluminum Construction, Matte Anodized Finish, Lightweight, with an Ultra Slim Profile
- One-piece Construction for a Tailored Fit
- All Edges and Corners Chamfered and Dehorned
- Carry-oriented Funnel Height and Angle Corrects Misaligned Magazine Insertions for Faster Reloads



- All Edges and Corners Chamfered and Dehorned
- One-piece Construction for a Tailored Fit
- Carry-oriented Funnel Height and Angle Corrects Misaligned Magazine Insertions for Faster Reloads

**NEW**



Item #	Black	PUMGL01	PUMGL02	PUMGL03	PUMGL04
Make/Model		Glock® 17, 22, 34 Gen. 3 or 4	Glock® 17, 34 Gen. 5	Glock® 19, 23 Gen. 3 or 4	Glock® 19 Gen. 5
Weight		.4oz	.4oz	.4oz	.4oz
Other Available Colors					
B=Blue	PUMGL01B	PUMGL02B	PUMGL03B	PUMGL04B	
R=Red	PUMGL01R	PUMGL02R	PUMGL03R	PUMGL04R	

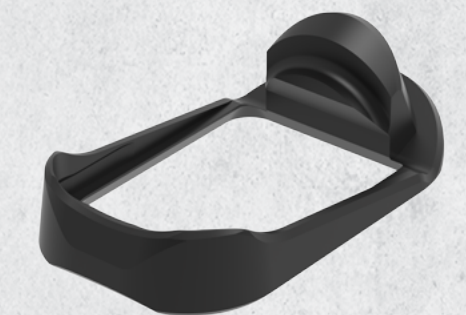



# AR15 OPS READY S4 4 POSITION STOCKS & ASSEMBLIES

PROUDLY MADE IN U.S.A.

- MADE IN USA
- HIGH STRENGTH POLYMER
- US PAT. D818074
- ADJUSTABLE STOCK

### Ultra Sub-compact Stock

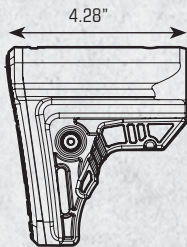

- AVAILABLE COLOR(S)
- BLACK POLYMER
- FDE POLYMER

- PARTS INCLUDED IN KIT

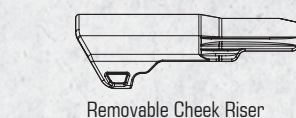

## UTG PRO® AR15 Ops Ready S4 4 Position Stocks & Assemblies

- Stock and Cheek Rest Molded from Impact Resistant High Strength Polymer
- Lightweight, Ultra Sub-compact Profile, Ideal for Compact Applications
- Built for Heavy Duty Use with the Tightest Tolerance Controls to Provide the Most Secure Fit and Function
- Included Removable Cheek Rest for Improved Shooting Stability and Comfort



Item #	RBUS4BM	RBUS4DM	RBUS4BMS	RBUS4DMS
Type	Mil-spec			
	Stock Assembly		Stock Only	
Color	Black	FDE	Black	FDE
Dimensions	4.28" Length x 1.69" Width x 4.75" Height			
Weight	15.50 oz		5.65 oz	



# AR15 OPS READY S3 6 POSITION STOCKS & ASSEMBLIES

PROUDLY MADE IN U.S.A.

- MADE IN USA
- HIGH STRENGTH POLYMER
- US PAT. D773005
- ADJUSTABLE STOCK

### Sub-compact Stock

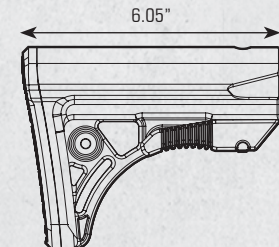

- AVAILABLE COLOR(S)
- BLACK POLYMER
- FDE POLYMER

- PARTS INCLUDED IN KIT

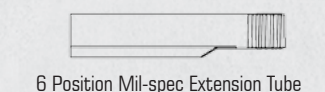

## UTG PRO® AR15 Ops Ready S3 6 Position Stocks & Assemblies

- Stock Molded from Impact Resistant High Strength Polymer
- Sub-compact Profile for Lightweight, Comfortable Performance
- Built for Heavy Duty Use with the Tightest Tolerance Controls to Provide the Most Secure Fit and Function



Item #	RBUS3BM	RBUS3DM	RBUS3BMS	RBUS3DMS
Type	Mil-spec			
	Stock Assembly		Stock Only	
Color	Black	FDE	Black	FDE
Dimensions	6.05" Length x 1.50" Width x 4.75" Height			
Weight	16.87 oz		7.02 oz	





# AR15 OPS READY S2 6 POSITION STOCKS AND ASSEMBLIES

PROUDLY MADE IN U.S.A.

- MADE IN USA
- HIGH STRENGTH POLYMER
- ADJUSTABLE STOCK

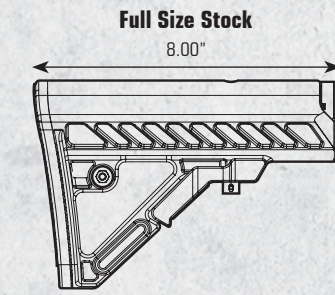

- AVAILABLE COLOR(S)  
BLACK POLYMER  
FDE POLYMER

- PARTS INCLUDED IN KIT



## UTG PRO® AR15 Ops Ready S2 6 Position Stocks and Assemblies

- Stock Molded from Impact Resistant High Strength Polymer
- Lightweight Slim Profile with Extended 7.50" Length for Increased Length of Pull
- Built for Heavy Duty Use with the Tightest Tolerance Controls to Provide the Most Secure Fit and Function



Extended Front End Enables Stock to be Flush with the Lower Receiver for a More Integral Look



Item #	RBUS2BM	RBUS2DM	RBUS2BMS	RBUS2DMS
Type	Mil-spec			
	Stock Assembly		Stock Only	
Color	Black	FDE	Black	FDE
Dimensions	8" Length x 1.50" Width x 5.25" Height			
Weight	19.65oz		9.92oz	



# AR15 OPS READY S1 6 POSITION STOCKS AND ASSEMBLIES

PROUDLY MADE IN U.S.A.

- MADE IN USA
- HIGH STRENGTH POLYMER
- ADJUSTABLE STOCK

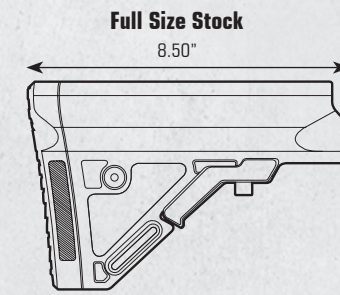

- AVAILABLE COLOR(S)  
BLACK POLYMER  
FDE POLYMER

- PARTS INCLUDED IN KIT

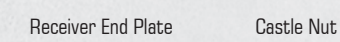
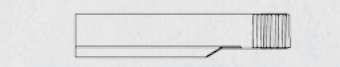

## UTG PRO® AR15 Ops Ready S1 6 Position Stocks and Assemblies

- Stock Molded from Impact Resistant High Strength Polymer
- Extended 8" Length for Increased Length of Pull
- Built for Heavy Duty Use with the Tightest Tolerance Controls to Provide the Most Secure Fit and Function



Extended Front End Enables Stock to be Flush with the Lower Receiver for a More Integral Look



Item #	RBUS1BM	RBUS1DM	RBUS1BMS	RBUS1DMS
Type	Mil-spec			
	Stock Assembly		Stock Only	
Color	Black	FDE	Black	FDE
Dimensions	8.50" Length x 2.25" Width x 5.50" Height			
Weight	23.05oz		12.60oz	



# AR15 OPS READY S5 FIXED STOCK

PROUDLY MADE IN U.S.A.



MADE IN USA



HIGH STRENGTH POLYMER



FIXED STOCK

Full Size Stock

10.52"

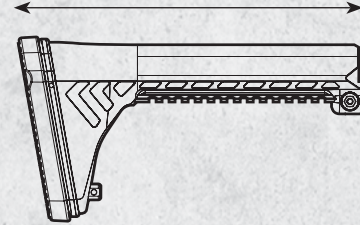

AVAILABLE COLOR(S)

BLACK POLYMER



PARTS INCLUDED



Stock Screw

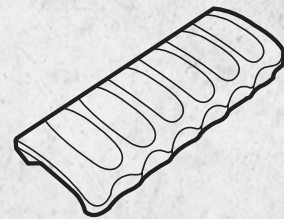

Picatinny Panel Covers (X2)

## UTG PRO® AR15 Ops Ready S5 Fixed Stock

- Stock Molded from Impact Resistant High Strength Polymer
- Built for Heavy Duty Use with the Tightest Tolerance Controls
- Slim Lightweight Ergonomic Profile
- Built-in Scalloped Picatinny Rail for Attaching Other Accessories



Item #	RBUS5B
Type	Stock Only
Color	Black
Dimensions	10.52" Length x 2" Width x 5.59" Height
Weight	14.80 oz



# AR15 & AR308 STANDARD BUTT STOCK ASSEMBLIES

## UTG PRO® AR15 Ops Ready U6 6 Position Stock Assemblies

- Stock Molded from Impact Resistant Polymer with Reinforced Stress Points for Maximum Durability
- Built for Heavy Duty Use with the Tightest Tolerance Controls to Provide the Most Secure Fit and Function
- Dual Standard Sling Loop Attachment Points
- Lightweight Design with a Classic Look and Feel



### ADDITIONAL ACCESSORIES AVAILABLE



## AR15 Ergonomic Butt Pad for U6 6 Position Collapsible Stock

- Provides Additional Comfort when Shouldered

## AR15 Standard A2 Fixed Butt Stock Assembly

- Stock Molded from Impact Resistant High Strength Polymer

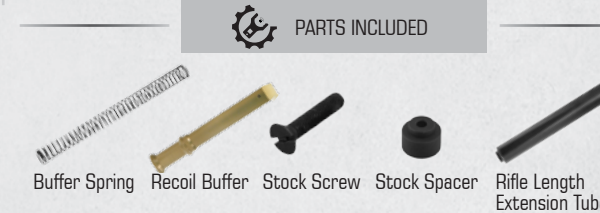

Item #	RBU6BM	RBU6DM	RBU6BC	RB-T469B	RB-T469D	RB-T308FB
Platform	AR15					
Type	6 Position Adjustable			Fixed A2		
	Stock Assembly					
	Mil-spec		Commercial-spec		N/A	
Color	Black	FDE	Black	Black	FDE	Black
Dimensions	6.88" Length x 1.68" Width x 5.15" Height			10.75" Length x 1.62" Width x 5.14" Height		
Weight	16.90oz	17oz	18.20oz	26.40oz		25.50 oz

## AR308 Standard A2 Fixed Butt Stock Assembly

- Stock Molded from Impact Resistant High Strength Polymer
- Compatible with Armalite AR-10, DPMS LR-308, S&W M&P10, and Other Clones



# AR15 & AR308 6 POSITION RECEIVER EXTENSION TUBES & KITS

PROUDLY MADE IN U.S.A.

- MADE IN USA
- PRECISION MACHINED
- 6065-T6 ALUMINUM
- 7075-T6 ALUMINUM

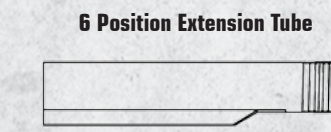

- AVAILABLE COLOR(S)
- MATTE BLACK ANODIZED
  - MATTE BLUE ANODIZED
  - MATTE RED ANODIZED
  - MATTE BRONZE ANODIZED
  - FDE CERAKOTE®

- PARTS INCLUDED IN KIT

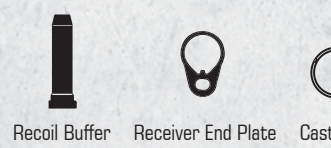

## UTG PRO® AR15 & AR308 6 Position Receiver Extension Tubes & Kits

- Extension Tube CNC Machined from 7075-T6 or 6061-T6 Aircraft Aluminum with Precisely Rolled Threads for Durable Thread Engagement with Lower Receiver
- Tightest Tolerance Controls for a Secure Fit and Function with Various Collapsible Stocks
- Finished in a Matte Black/Blue/Red/Bronze Type III Class II Hard Coat Anodization or FDE CERAKOTE®



	7075-T6					6061-T6				
<b>AR15 Mil-spec 6 Position Receiver Extension Tubes</b>	BLACK	BLUE	RED	BRONZE	FDE	<b>AR15 Mil-spec 6 Position Receiver Extension Tube Kits</b>	BLACK	FDE	<b>AR15 Commercial-spec 6 Position Receiver Extension Tube</b>	<b>AR308 6 Position Receiver Extension Tube</b>
	TLU001MS	TLU001	TLU001B	TLU001R	TLU001Z	TLU001D	TLU001-KIT	TLU001D-KIT	TLU006	TLU002

Item # (Model)	TLU001-KIT	TLU001D-KIT	TLU001MS	TLU001	TLU001R	TLU001B	TLU001Z	TLU001D	TLU006	TLU002
Platform	AR15								AR308	
Type	Mil-spec								Commercial-spec	Mil-spec
	Tube Kit		Tube Only							
Material	6061-T6		7075-T6			6061-T6				
Color	Black	FDE	Black	Black	Red	Blue	Bronze	FDE	Black	
Dimensions	7.25"x1.14"x1.44"								7.80"x1.17"x1.45"	7.90"x1.14"x1.44"
Weight	9.25oz		4oz						5oz	4oz

# AR PISTOL RECEIVER EXTENSION TUBES & KITS

## UTG PRO® AR Pistol Receiver Extension Tube & Kits

- 1.2" OD Receiver Extension Tube Compatible with AR15 Lower Receivers
- Precision Machined from 7075-T6 Aircraft Aluminum with a Dry Film Lube Coated Interior for Smoother and More Reliable Cycling
- Finished in a Matte Black Type III Class II Hard Coat Anodized Finish
- Compatible with Standard AR15 Type Buffers and Springs
- Compatible with Most AR Pistol Receiver Extension Tube Covers



	BLACK	BLACK
<b>AR Pistol Receiver Extension Tube</b>	TLU008	
<b>AR Pistol Receiver Extension Tube Kit</b>		TLU008-KIT

Item # (Model)	TLU008	TLU008-KIT	TLU009	TLU009-KIT
Platform	AR Pistol			
Type	Tube Only	Tube Kit	Tube Only	Tube Kit
Material	7075-T6			
Color	Black			
Dimensions	OD 1.2"x7.24"		OD 1.25"x8.5"	
Weight	4oz	9.9oz	6.2oz	12.2oz

## UTG PRO® AR Pistol Extended Receiver Extension Tube & Kits

- Precision Machined from 7075-T6 Aircraft Aluminum with a Dry Film Lube Coated Interior for Smoother and More Reliable Cycling
- Finished in a Matte Black Type III Class II Hard Coat Anodized Finish
- Compatible with Standard AR15 Type Buffers and Springs
- 8.5" Extended Length and Compatible with Gear Head Works Tailhook Mod 1 Brace and or Most AR Pistol Receiver Extension Tube Covers



	BLACK	BLACK
<b>AR Pistol Extended Receiver Extension Tube</b>	TLU009	
<b>AR Pistol Extended Receiver Extension Tube Kit</b>		TLU009-KIT

**ADDITIONAL ACCESSORIES AVAILABLE**

Item # (Model)	RB-T6BFH3	RB-T6BFH2	RB-T6BFHC
<b>AR15 H3 Recoil Buffer</b>	<ul style="list-style-type: none"> <li>3 Heavy Tungsten Weights</li> <li>Total Weight 5.4 oz</li> <li>[Also Refer to P.144]</li> </ul>		
<b>AR15 H2 Recoil Buffer</b>	<ul style="list-style-type: none"> <li>2 Heavy Tungsten Weights and 1 Steel Weight</li> <li>Total Weight 4.6 oz</li> <li>[Also Refer to P.144]</li> </ul>		
<b>AR15 Carbine Recoil Buffer</b>	<ul style="list-style-type: none"> <li>3 Steel Weights</li> <li>Total Weight 3.0 oz</li> <li>[Also Refer to P.144]</li> </ul>		



# AR15 FLIP-UP FRONT / REAR SIGHTS & TOOLS

NEW



TLUF5003

## UTG PRO® Spring-loaded Flip-up Front Sight

- Precision Machined from Aircraft Aluminum with a Matte Black Anodized Finish
- Push-button Activated Sight Tower Automatically Locks into the Upward Position when Deployed
- Standard Elevation Adjustable A2 Front Sight Post is Interchangeable with Most Aftermarket Posts
- Utilizes a Single Locking Torx Screw and Square-shaped Integral Recoil Stops for a Secure Zero Hold and Return to Zero on Picatinny Rails

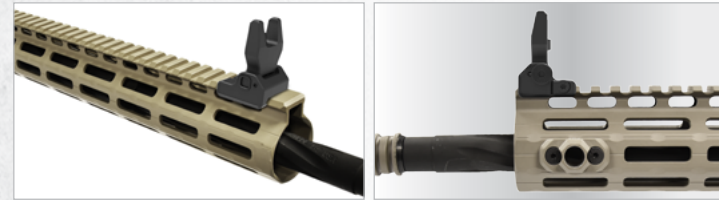

NEW



TLUR5003

## UTG PRO® Spring-loaded Flip-up Rear Sight

- Precision Machined from Aircraft Aluminum with a Matte Black Anodized Finish
- Push-button Activated Sight Tower Automatically Locks into the Upward Position when Deployed
- Dual Aperture Rear Sight with Tool-free Windage Adjustment Wheel
- Utilizes a Single Locking Torx Screw and Square-shaped Integral Recoil Stops for a Secure Zero Hold and Return to Zero on Picatinny Rails



US PAT. 10030935



PATENT PENDING

MNT-745

## ACCU-SYNC® 45 Degree Flip-up Front Sight

- Precision Machined from Aircraft Aluminum with a Matte Black Finish
- 45 Degree Angled Offset Allows Access to Iron Sights Simultaneously with Primary Mounted Magnified Optics
- Posi-lock Retention Plunger Locks Sight in Deployed Position
- Tool-free Front Sight Post Elevation Adjustment Wheel
- Utilizes a Single Locking Torx Screw and Square-shaped Integral Recoil stops for a Secure Zero Hold and Return to Zero on Picatinny Rails



US PAT. 10030935



PATENT PENDING

MT-945

## ACCU-SYNC® 45 Degree Flip-up Rear Sight

- Precision Machined from Aircraft Aluminum with a Matte Black Finish
- 45 Degree Angled Offset Allows Access to Iron Sights Simultaneously with Primary Mounted Magnified Optics
- Posi-lock Retention Plunger Locks Sight in Deployed Position
- Dual Aperture Rear Sight with Tool-free Windage Adjustment Wheel
- Utilizes a Single Locking Torx Screw and Square-shaped Integral Recoil Stops for a Secure Zero Hold and Return to Zero on Picatinny Rails



US PAT. 10119784



PATENT PENDING

MNT-757

## ACCU-SYNC® Spring-loaded Flip-up Front Sight

- Precision Machined from Aircraft Aluminum with a Matte Black Finish
- Lightweight, Space Saving, Fold Over Design Uses Minimal Rail Space
- Posi-lock Push Button Automatically Deploys the Spring Loaded Sight and Prevents Sight from Collapsing when Deployed
- Utilizes a Single Locking Torx Screw and Square-shaped Integral Recoil Stops for a Secure Zero Hold and Return to Zero on Picatinny Rails



US PAT. 10119784



PATENT PENDING

MNT-957

## ACCU-SYNC® Spring-loaded Flip-up Rear Sight

- Precision Machined from Aircraft Aluminum with a Matte Black Finish
- Lightweight, Space Saving, Fold Over Design Uses Minimal Rail Space
- Posi-lock Push Button Automatically Deploys the Spring Loaded Sight and Prevents Sight from Collapsing when Deployed
- Dual Aperture Rear Sight with Tool-free Windage Adjustment Wheel
- Utilizes a Single Locking Torx Screw and Square-shaped Integral Recoil Stops for a Secure Zero Hold and Return to Zero on Picatinny Rails



MNT-755

## Low Profile Flip-up Front Sight

- Aluminum/Steel Construction with a Matte Black Finish
- Standard A2 Front Sight Post with Precise Elevation Adjustment
- Low Profile 3mm Locking Bolt and Mounting Deck Securely Attaches to any Picatinny Rail



MNT-955

## Low Profile Flip-up Rear Sight

- Aluminum/Steel Construction with a Matte Black Finish
- Dual Aperture Rear Sight with Tool-free Windage Adjustment Wheel
- Low Profile 3mm Locking Bolt and Mounting Deck Securely Attaches to any Picatinny Rail

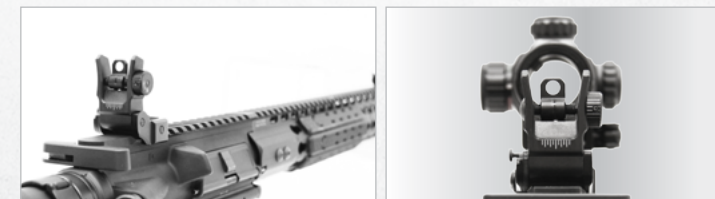

SCP-FTA24

## 4-Prong A2 Front Sight Tool

- Machined Steel with Knurled Surface Texture
- For Use on 4-prong A2 Front Sight Posts

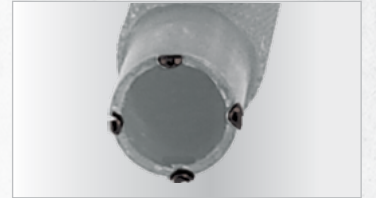

SCP-A1245-A

## Dual A2 Front Sight Tool

- Machined Steel with Knurled Surface Texture
- For Use on Both 4 and 5-prong Front Sight posts

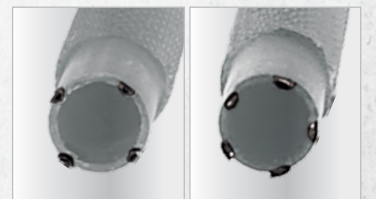
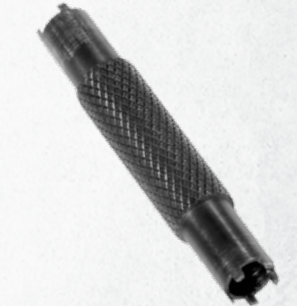



# AR15 FIXED FRONT & REAR SIGHTS



# AR15 CARRY HANDLE SIGHTS



# SHOTGUN SIGHTS



**LOW PROFILE SIGHT**  
FOR SAME PLANE APPLICATIONS

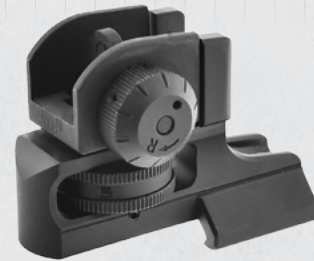

**Super Slim Rear Sight** (Designed to Match MT-754X Front Sight)

- Low Profile Super Slim Front Sight** (Designed to Match MT-950RS03 Rear Sight)
- Low Profile Front Sight with Adjustable A2 Front Sight Post, Fits on Picatinny Handguard or High Profile Gas Block Leveled with Flat Top Upper Receiver
  - Utilizes a Locking Torx Screw Side Plate and Integral Square-shaped Recoil Stop to Ensure a Secure Zero Hold
  - CNC Machined 6061-T6 Aircraft Aluminum and Steel Construction with a Matte Black Finish

- Precision CNC Machined 6061-T6 Aircraft Aluminum Base with Steel A2 Sight Assembly
- Slim and Lightweight Profile with a Durable Wear Resistant Matte Black Finish
- Tool-free Windage and Elevation Adjustment with Dual Apertures
- Utilizes a Single Locking Torx Screw and Square-shaped Integral Recoil Stop for a Secure Zero Hold and Return to Zero on MIL-STD-1913 Picatinny Rails



**HIGH PROFILE SIGHT**  
FOR LOWERED OFFSET GAS BLOCK APPLICATIONS



**Mil-Spec Compact A2 Rear Sight**

- High Profile Super Slim Front Sight** (MT-750X)
- High Profile Front Sight with Adjustable A2 Front Sight Post, Fits Lowered Offset Picatinny Railed Gas Blocks
  - Utilizes a Locking Torx Screw Side Plate and Integral Square Shaped Recoil Stop to Ensure a Secure Zero Hold
  - CNC Machined 6061-T6 Aircraft Aluminum and Steel Construction with a Matte Black Finish

- Precision Machined from Aircraft Aluminum and Steel with a Matte Black Finish
- Slim Profile and Base Uses Minimal Rail Space
- Tool-free Windage and Elevation Adjustment Steel A2 Sight Assembly with Dual Apertures
- Low Profile Locking Retention Thumb Wheel and Side Plate

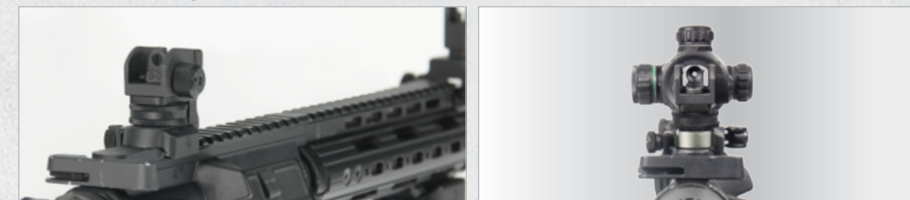

**UTG PRO® Mil-spec Forged Carry Handle Sight**

- Mil-spec Match Grade Detachable Carry Handle with A2 Sight Assembly
- Picatinny Mounting Base with Full Length Locking Plate and Dual Oversized Locking Thumb Wheels
- Forged 7075-T6 Aluminum and Steel Construction Finished in a Matte Black Anodization
- Steel A2 Sight Assembly Provides Precise and Reliable Windage/Elevation Adjustment, Complete with Dual Aiming Apertures



**Enhanced Carry Handle Rear Sight** (OEM)

- Utilizes a Full Length Two Point Locking Side Plate with Low Profile Thumb Wheels and Four Integral Recoil Stops to Ensure a Secure Zero Hold
- CNC Machined 6061-T6 Aluminum and Steel Construction with a Matte Black Finish



**MNT-910 Sub-compact Rear Sight**

- Precision Machined Aircraft Aluminum with a Matte Black Finish
- Designed to Match MNT-722 & 716 Clamp-on Front Sights
- Optimally Sized Aiming Aperture
- Complete Windage/Elevation Adjustment in an Extremely Sub-compact and Lightweight Design
- One Piece Integral Picatinny Mounting Base



For Mossberg 12 Ga. & Clones

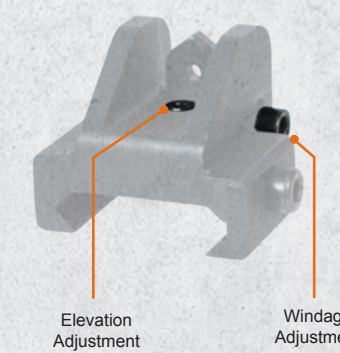
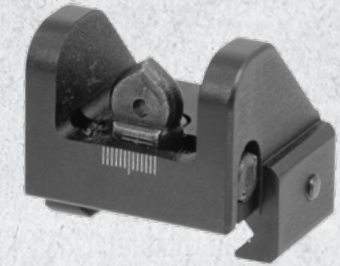

**MNT-722 Clamp-on Front Sight With Elevation Adjustable Front Sight Post**

- Fits Mossberg 12Ga. Shotgun and Clones Equipped with Front Sight Bead
- Designed to Match MNT-910 Sub-compact Rear Sight
- Complete with 2 in 1 Sight Adjustment Tool



For Mossberg 12 Ga. & Clones

Elevation Locking Set Screw







**TL-ARCH01**  
**Standard Charging Handle**

- Forged from Aircraft Aluminum Construction with a Matte Black Finish
- Compatible with Standard Mil-spec AR15 Upper Receivers



**NEW**  
**TL-TKSCH**  
**Ambi Charging Handle**

- Minimalist Inspired, Unobtrusive, and Designed to Have a Classic Look and Feel
- Aircraft Aluminum Construction with a Matte Black Finish
- Ambidextrous Design



**NEW**  
**TL-TKSLT**  
**Adjustable Safety Selector**

- Changeable Between a 45 or 90 Degree Throw
- Features Interchangeable and Different Length and Shape Safety Levers for a Tailored Fit and Function Specific to the User
- Ambidextrous Design
- For Semi-automatic Fire Control Groups Only



**NEW**  
**TL-TKSBC**  
**Enlarged Bolt Catch**

- Angled and Enlarged Surfaces Facilitate Faster Reloads and Malfunction Clearing



**TL-CHL01**  
**Extended Charging Handle Latch**

- Increased Surface Area for Faster Manipulation Under Stress
- Heavy Duty Steel Construction with a Matte Black Finish
- Fits Standard AR15 Charging Handles



**NEW**  
**TL-TKSTG**  
**Enlarged Trigger Guard**

- Optimized Geometry for Use While Wearing Gloves
- Closes the Gap Found Between the Rear of the Trigger Guard and the Front of the Pistol Grip

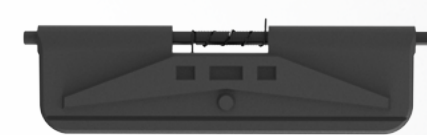

**NEW**  
**TL-TKSDC**  
**Quick Assemble Dust Cover**

- Tool-free Design and Installation



**NEW**  
**TL-TKSMB**  
**Ambi Mag Release**

- Enlarged Surface Face For Easier Gloved Manipulation and Reach
- Clearance Cut to Prevent Unintentional Interference with Bolt Catch



**RB-T6BFH3**  
**AR15 H3 Recoil Buffer**

- 3 Heavy Tungsten Weights
- Potentially Increases Dwell Time, Eases Extraction, and Reduces Felt Recoil
- Total Weight 5.4 oz



**RB-T6BFH2**  
**AR15 H2 Recoil Buffer**

- 2 Heavy Tungsten Weights and 1 Steel Weight
- Potentially Increases Dwell Time, Eases Extraction, and Reduces Felt Recoil
- Total Weight 4.6 oz



**RB-T6BFHC**  
**AR15 Carbine Recoil Buffer**

- 3 Steel Weights
- Total Weight 3.0 oz



**RB-T6BM-50**  
**Carbine Buffer Spring**

- Steel Construction

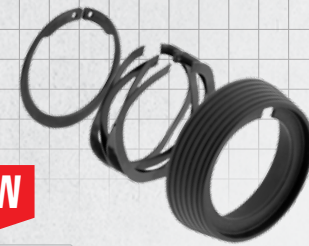

**NEW**  
**TL-ARDR01**  
**Standard Delta Ring Assembly**

- Aircraft Aluminum and Steel Construction with a Matte Black Finish
- Compatible with Standard Mil-Spec AR15 Upper Receivers
- Includes Delta Ring, Weld Spring, and Snap Ring

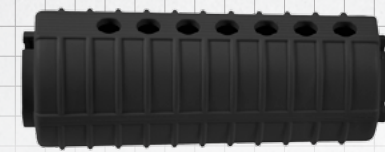

**RB-TM4HBT**  
**Polymer Drop-in Handguard**

- Quality Replacement Handguard for Carbine-length AR15
- Rounded Shape with Dual Aluminum Heat Shields
- Lightweight and Extremely Tough for Use Under All Weather and Environmental Conditions



**NEW**  
**TL-ARFS01**  
**Standard A2 Front Sight Gas Block**

- Design to Fit Pinned Barrel with a .750" Dia. at the Gas Port
- Solid Steel Construction with a Matte Black Finish
- Comes Complete with Standard Front Sight Post, Spring, Detent, and Sling Swivel

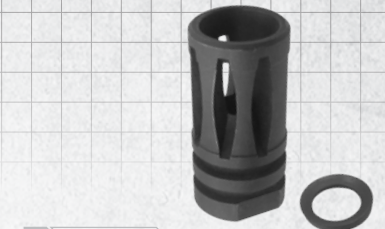

**TL-ARFH01**  
**Standard A2 Flash Hider**

- Steel Construction with a Matte Black Hard Coat Manganese Phosphate Surface Treatment
- 1/2"-28 UNEF Thread
- Includes Crush Washer



**TL-T6TD03**  
**QD Receiver End Plate**

- Designed for Standard Mil-spec AR15 Lower Receiver
- Accepts Any Quick Detach Sling Swivel with 0.37" Diameter Swivel Stud
- Solid Steel Construction with a Matte Black Finish



**NEW**  
**TL-ARBRO1**  
**Standard Steel Barrel Nut**

- Heavy Duty Steel Construction with a Matte Black Finish
- Compatible with Standard Mil-Spec AR15 Upper Receivers



**NEW**  
**MNT-ARMGB01**  
**Micro Gas Block**

- Low Profile Size Fits Underneath Most Free Float Handguards
- Precision Machined from Steel to Exacting Tolerances for Optimal Fit on .750" Diameter Barrels at the Gas Port
- Features a Durable and Corrosion Resistant Manganese Phosphate Finish
- Compatible with Direct Impingement Gas Tubes
- Includes Gas Tube Roll Pin, Serrated Self-locking Set Screws, and Installation Tool



**TLUMD01**  
**UTG PRO® Stubby Muzzle Brake**

- Steel Construction Finished in a Matte Black Manganese Phosphate Surface Treatment for Corrosion Resistance
- 1/2"-28 UNEF Thread Compatible, Crush Washer Included
- 1.75" Length with Three Left and Right Sided Gas Dispersion Ports for Improved Recoil Reduction and Handling



**RB-T6BM-30** **OEM**  
**Receiver End Plate**

- Designed for Standard Mil-spec AR15 Lower Receiver
- Solid Steel Construction with a Matte Black Finish



**RB-T6BM-40** **OEM**  
**Castle Nut**

- Designed for Standard Mil-spec AR15's
- Solid Steel Construction with a Matte Black Finish

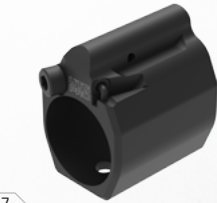

**NEW** **MTU012AG7**  
**UTG PRO® Adjustable Micro Gas Block**

- 12 Position Gas Port Adjustments
- Low Profile, Fits Underneath Most Free Float Handguards
- Precision Machined to Exacting Tolerances for .750" Diameter Barrels at the Gas Port
- Features a Durable and Corrosion Resistant Manganese Phosphate Finish
- Compatible with Direct Impingement Gas Tubes
- Includes Gas Tube Roll Pin, Serrated Self-locking Set Screws, Adjustment Tool, and Installation Tool



**NEW** **TLUMD02**  
**UTG PRO® Muzzle Brake**

- Steel Construction Finished in a Matte Black Manganese Phosphate Surface Treatment for Corrosion Resistance
- 1/2"-28 UNEF Thread Compatible, Crush Washer Included
- 2.25" Length with Four Left and Right Sided Gas Dispersion Ports for Improved Recoil Reduction and Handling



# AR & AK/AKM POLYMER MAGAZINES



**NEW**

RBT-AM30

## AR15 30 Round Windowed Polymer Magazine

- Molded from Impact Resistant High Strength Reinforced Polymer
- High Contrast Blue Anti-tilt and Self-lubricating Follower
- Aggressively Molded Grip Texture on the Forward and Rearward Spine and Side Walls
- Windowed with Numbered Markings to Show Capacity Remaining
- Simple to Remove Base Plate for Cleaning

**NEW**

RBT-AM10

## AR15 10 Round Polymer Magazine

- Molded from Impact Resistant High Strength Reinforced Polymer
- High Contrast Blue Anti-tilt and Self-lubricating Follower
- Aggressively Molded Grip Texture on the Forward and Rearward Spine and Side Walls
- Simple to Remove Base Plate for Cleaning



**NEW**

RBT-AKM30

## AK47 30 Round Windowed Polymer Magazine

- Molded from Impact Resistant High Strength Reinforced Polymer
- Reinforced Front and Rear Locking Lugs for Increased Longevity
- High Contrast Blue Anti-tilt and Self-lubricating Follower and Constant Internal Geometry for Reliable Feeding
- Aggressively Molded Grip Texture on the Forward and Rearward Spine and Side Walls
- Windowed with Numbered Markings to Show Capacity Remaining
- Simple to Remove Base Plate for Cleaning



# AR PLATFORM ARMORER'S WRENCHES

TL-ARWR01

## AR15/AR308 Armorer's Multi-function Combo Wrench

- Provides the Tools to Install and Remove Parts Often Replaced and or Reinstalled on Both the AR15 and AR308 Platforms such as: Standard A2 Flash Hider, Delta Ring Barrel Nut Assembly, Rifle Length Buffer Tube, Carbine Buffer Tube Castle Nut, and More
- Steel Construction with Wear Resistant Finish for Long Lasting Durability



TL-ARWR02

## Mini AR15 Armorer's Wrench

- Provides the Tools to Install and Remove Parts Often Replaced and or Reinstalled on the AR15 Platforms such as: Standard A2 Flash Hider, Delta Ring Barrel Nut Assembly, Rifle Length Buffer Tube, Carbine Buffer Tube Castle Nut, and More
- Steel Construction with Wear Resistant Finish for Long Lasting Durability

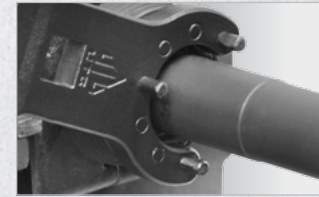

1. Delta Ring Barrel Nut

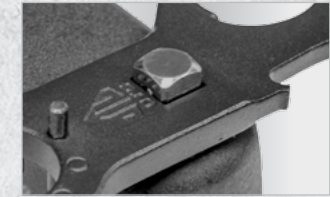

2. 1/2" and or 3/8" Socket Adaptor



3. Jam Nut - YHM® Compatible



4. UTG PRO® Super Slim Barrel Nut

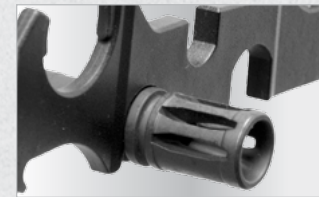

5. AR15 Muzzle Device



6. A2 Stock Extension Tube

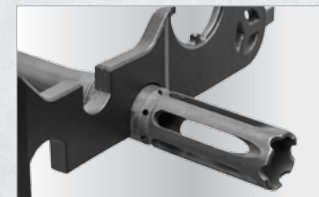

7. AR308 Muzzle Device



8. Castle Nut



9. 3-prong Muzzle Device



10. Flat Head Screw Driver



# ANGLED FOREGRIPS, INDEX MOUNTS, & HANDSTOPS

ACCESSORIES AND PARTS

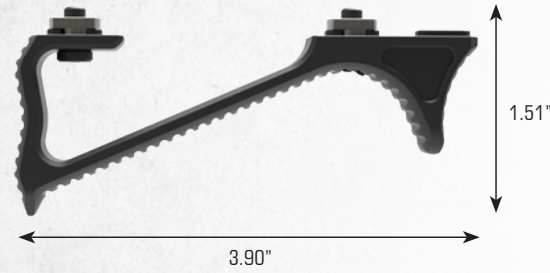

**NEW**

## M-LOK®, Keymod, & Picatinny Angled Foregrrips

- 6061-T6 Aluminum Construction Available in Matte Black, Blue, or Red Anodization, and Available for M-LOK®, Keymod, and Picatinny Modular Systems
- Weight Reduction Lightening Cuts, Ergonomic Contours, and Serrated Front, Bottom, and Rear Faces for Added Grip Retention
- Promotes Proper Support Hand Memory Placement and Retention

### Additional Colors Available

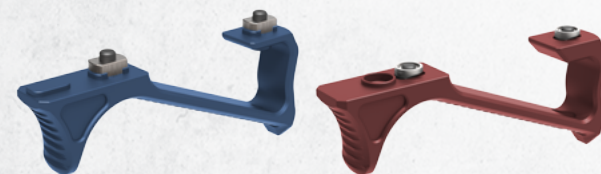

Item #	Black	MT-AFGP01	MT-AFGM01	MT-AFGK01
Type		PICATINNY	M-LOK®	KEYMOD
Other Available Colors		N/A	MT-AFGM01B MT-AFGM01R	MT-AFGK01B MT-AFGK01R
			AB=Blue	AR=Red



PICATINNY

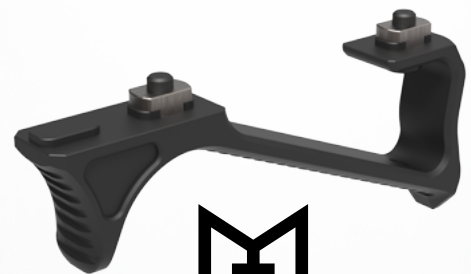

M-LOK



KEYMOD



Side



Top



**NEW**

M-LOK®	TL-TRM01		PATENT PENDING
KEYMOD	TL-TRK01		

## M-LOK® & Keymod Angled Index Mounts

- Precision Machined from 6061-T6 Aluminum and Finished in a Matte Black Anodization
- Provides an Additional Support Hand Indexing and Retention Point
- Reversible Design for Installation at the 3 or 9 O'clock Handguard Positions
- Compatible with the Majority of Octagonal Handguards
- Thumb Indexing Deck Configurable for Forward or Rearward Cant
- Spacer Included for Adjusting Clearance with 12 O'clock Mounted Accessories and Pressure Switches

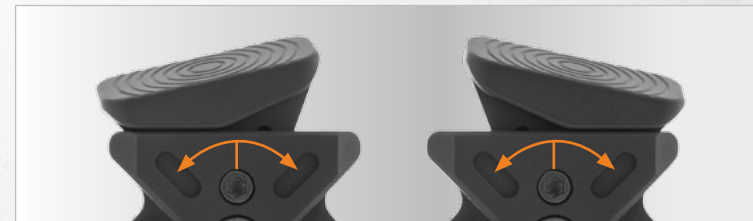

Reversible Design for Installation at the 3 or 9 O'clock Handguard Positions

**NEW**

## M-LOK® & Keymod Ultra Slim Hand Stops

- 6061-T6 Aluminum Construction Available in Matte Black, Blue, or Red Anodization for M-LOK® or Keymod Modular Systems
- Weight Reduction Lightening Cuts, Ergonomic Contours, and Serrated Front, Bottom, and Rear Faces for Added Grip Retention
- Promotes Proper Support Hand Memory Placement and Retention

### Additional Colors Available



Item #	Black	TL-HSM01	TL-HSK01
Type		M-LOK®	KEYMOD
Other Available Colors		TL-HSM01B TL-HSM01R	TL-HSK01B TL-HSK01R
		AB=Blue	AR=Red



M-LOK

KEYMOD



Reversible Design is Customizable to the User's Specific Requirements

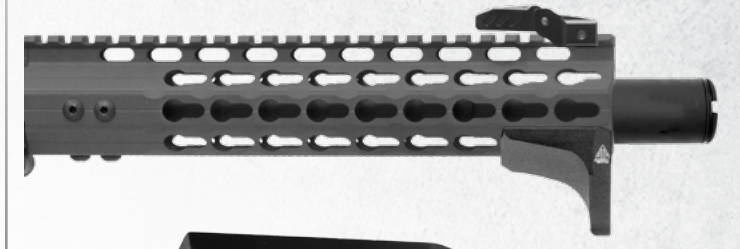

KEYMOD

TL-HS02B

## Keymod Hand Stop/Barricade Rest Kit

- 6061-T6 Aircraft Aluminum Construction with a Matte Black Finish
- Compatible with UTG PRO® Super Slim AR15/AK Keymod Handguards
- Ergonomic Contour Improves Firearm Handling and Speeds Up Transitions
- Promotes Proper Support Hand Memory Placement and Retention



Mount as a Barricade Rest to Provide Stable Support for more Accurate Shooting

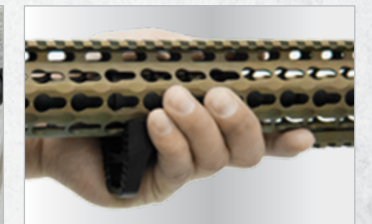

Promotes Proper Support Hand Memory Placement and Retention

ACCESSORIES AND PARTS

ANGLED FOREGRIPS, INDEX MOUNTS, & HANDSTOPS

ANGLED FOREGRIPS, INDEX MOUNTS, & HANDSTOPS



# ALUMINUM VERTICAL FOREGRIPS

## Super Slim Aluminum Vertical Foregrips

- Precision CNC Machined from Aircraft Aluminum Finished in a Matte Black Anodization
- Removable Red and Blue Anodized Inserts for M-LOK® and Keymod Models Adds a Level of Personalization
- Slim, lightweight, ergonomic, with dehorned corners and melted contours for a comfortable support hand grip

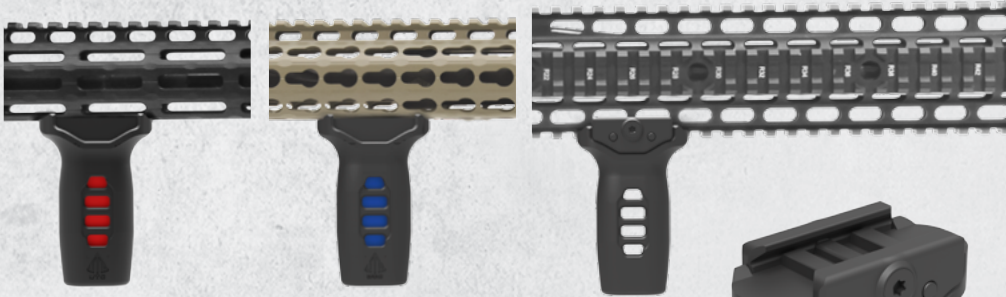

### Removable Red & Blue Anodized Inserts Included (For M-LOK & Keymod Only)



- NEW** MT-FGM01 M-LOK® Foregrip
- NEW** MT-FGK01 Keymod Foregrip
- NEW** MT-FGP01 Picatinny Foregrip

Item # (Model)	MT-FGM01	MT-FGK01	MT-FGP01	MNT-GRP001Q	MNT-GRP001SQ	MNT-GRP003Q
Operation				Fixed		
Width	1.5"	1.5"	1.5"	1.4"	1.4"	0.9"
Saddle Height	3.45"	3.45"	3.44"	4.90"	3.90"	3.45"
Weight	4.9oz	4.9oz	4.9oz	8.70oz	7.60oz	3.20oz
Total Storage Space	N/A	N/A	N/A	2.70in <sup>3</sup>	1.46in <sup>3</sup>	0.90in <sup>3</sup>

## Aluminum QD Vertical Foregrips

- Precision Machined from Aircraft Aluminum with a Matte Black Finish
- Quick Detachable Picatinny Lever Lock Mounting Base
- Posi-lock Cross Bolt and Spring Tensioned Locking Plate with Steel Insert for a Secure Installation
- Removable End Cap with Waterproof Storage within Foregrip
- Ergonomic Knurled Surface

US PATENT 8,429,843



US PATENT 8,397,421



- MNT-GRP001Q 5" QD Foregrip
- MNT-GRP001SQ 4.1" QD Foregrip
- MNT-GRP003Q 3.6" QD Foregrip



- MNT-GRP002SQ 4.7" QD Foldable Foregrip

Item # (Model)	MNT-GRP002SQ
Operation	Foldable
Width	1.4"
Saddle Height	4.60"
Weight	9.70oz
Total Storage Space	1.04in <sup>3</sup>



# POLYMER VERTICAL FOREGRIPS

- BLACK RB-FGRP170B
- FLAT DARK EARTH RB-FGRP170D

## 5 Position Foldable Foregrip

- End Cap Provides Battery Storage and Mount Tension
- Side Inserts Allow for Use of Pressure Switch
- Simple Slide-on Mounting Deck
- Reinforced Locking Mechanism for Added Durability
- 5 Position Adjustable

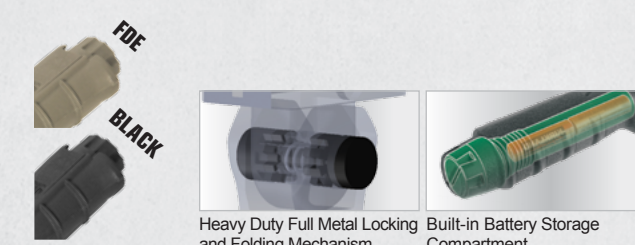

### 5 POSITION FOLDABLE



- BLACK RB-FGRP168B

## Ambidextrous Vertical Foregrip

- End Cap Provides Battery Storage and Mount Tension
- Side Inserts Allow for Use of Pressure Switch
- Simple Slide-on Mounting Deck
- Ergonomic Finger Grooves and Nonslip Grip Texture
- Molded from Impact Resistant Polymer

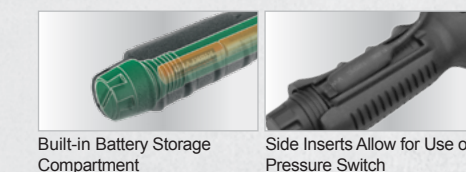

- BLACK RB-FGRP172B

## Ambidextrous Contoured Foregrip

- Contoured Finger Grooves for a Solid and Repeatable Grip
- Symmetrically Shaped Palm Swell with Nonslip Texture
- Removable End Cap with Storage Compartment within Foregrip
- Molded from Impact Resistant Polymer



Item # (Model)	RB-FGRP170B	RB-FGRP170D	RB-FGRP168B	RB-FGRP172B
Operation	Foldable		Fixed	
Color	Black	FDE	Black	Black
Length	1.57"		1.70"	2.25"
Saddle Height	5.60"		5.37"	4.50"
Weight	6.90oz		6.80oz	6oz



# AR15 PISTOL GRIPS

Item # (Model)	RBUPG01B	RBUPG01D	RBUPG02B	RBUPG02D
Color	Black	FDE	Black	FDE
Material	Polymer			
Height	4.60"		4.83"	
Weight	3.70oz		3.06oz	

Item # (Model)	RB-TPG172B	RB-TPG172D	RB-TPG269B	RB-TPG269G
Color	Black	FDE	Black	OD Green
Material	Polymer with Rubberized Coating			
Height	4.83"		4.60"	
Weight	5.10oz		4.80oz	4.70oz

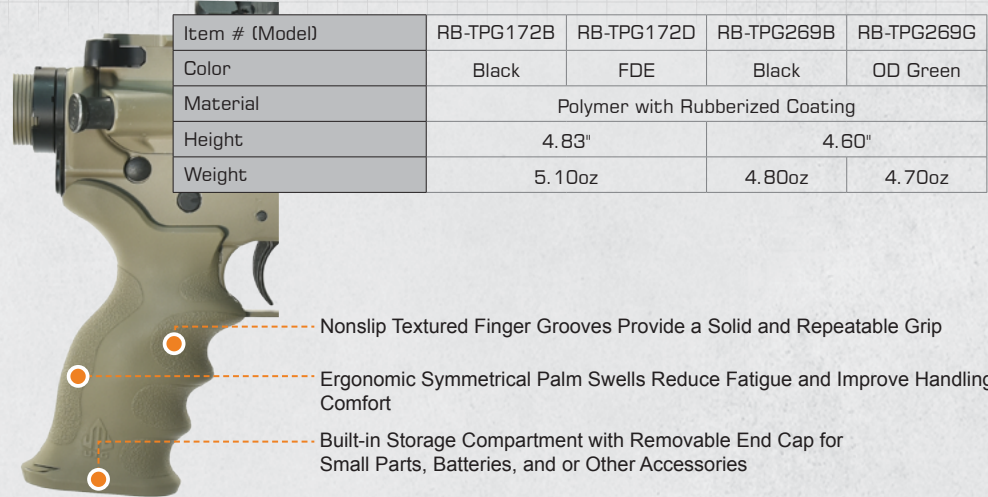
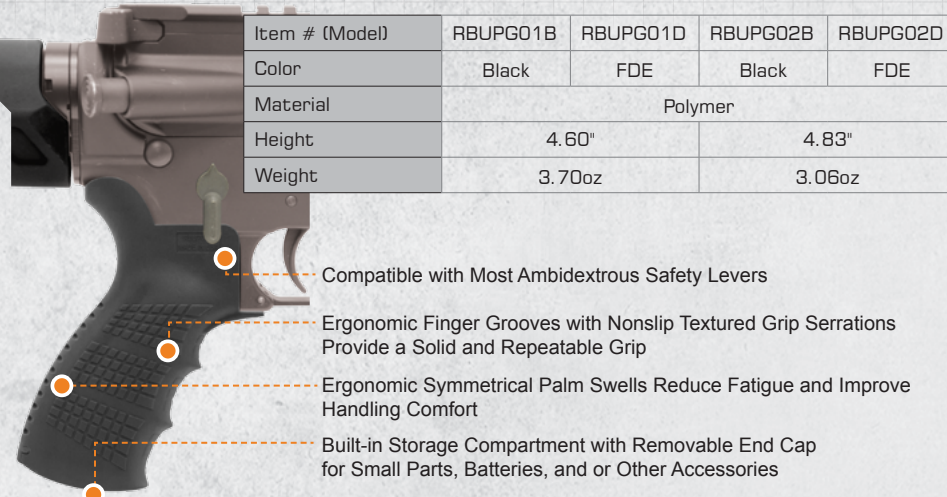

**AMBIDEXTROUS**  
Compatible with  
Ambi Safeties



**AMBIDEXTROUS**  
Compatible with  
Ambi Safeties



**RIGHT HAND**



**RIGHT HAND**



**NEW**

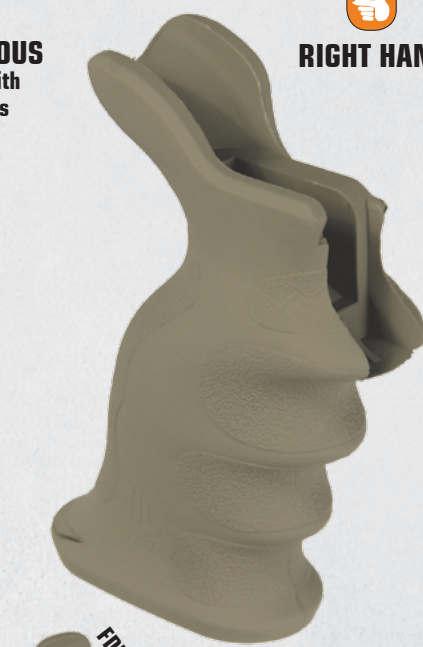

BLACK RBUPG01B  
FDE RBUPG01D

**Ambidextrous Contoured  
Pistol Grip**

BLACK RBUPG02B  
FDE RBUPG02D

**Ambidextrous Pistol Grip**

BLACK RB-TPG172B  
FDE RB-TPG172D

**Combat Sniper Pistol Grip**

BLACK RB-TPG269B  
OD GREEN RB-TPG269G

**Ergonomic Pistol Grip**



# RAIL PANEL COVERS

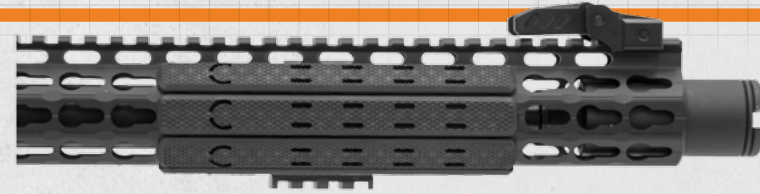

RB-HP25B (Set of 7)

## Low Profile Keymod Rail Panel Covers

- 5.5" in Length, Slim, Lightweight, and Securely Fits Into Standard Keymod Rail Slots
- Unique Aggressive Honeycomb Nonslip Textured Design Provides a Sure Grip Every Time
- Heat Resistant Polymer Construction

US PAT. 9989328



Bidirectional to Accommodate  
Installation around Other  
Mounted Accessories



Simple and Secure Slide and  
Snap-on Installation



RB-HP30M (Set of 4)

## Low Profile M-LOK® Rail Panel Covers

**NEW**

- 3.15" in Length, Slim, lightweight, and Securely Installs via Two M-LOK® Screws and Nuts
- Unique Aggressive Nonslip Textured Design Provides a Sure Grip Every Time
- Molded from Durable Impact and Heat Resistant Polymer with a Rubberized Overmold for Added Grip Traction



Bidirectional to Accommodate  
Installation around Other  
Mounted Accessories

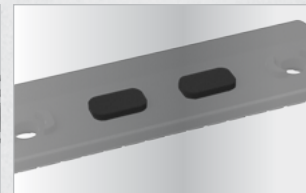

Simple and Secure Installation

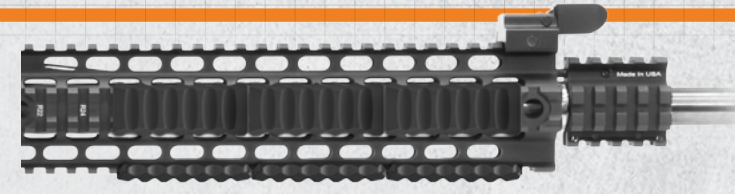

RB-HP27B (Set of 6)

## Low Profile Picatinny Panel Covers

- Molded from Durable Impact and Heat Resistant Polymer
- 2.7" in Length, Slim, Lightweight, and Securely Fits into Any Picatinny Rail
- Unique Scalloped Design Provides a Comfortable Nonslip Gripping Surface While Protecting the Rail Underneath it
- 6 Panels Per Pack, Matte Black



2.7" in Length, Slim, Lightweight,  
and Securely Fits into Any  
Picatinny Rail



Simple and Secure Snap-on  
Installation with Posi-lock Stop  
Bar to Prevent Shifting



BLACK RB-HP12B-B  
OD GREEN RB-HP12G-B  
FLAT DARK EARTH RB-HP12D-B

US PAT. 6725594  
US PAT. D730474

## Low Profile Picatinny Rubber Rail Guard (Set of 12)

- Provides a More Comfortable Gripping Surface
- Easily Snaps onto Picatinny Rails Without Shifting due to Integral Stop Bar
- Protects the User from Sharp Rail Edges While Protecting the Rail Itself



2" in Length, Slim, Lightweight,  
and Securely Fits into Any  
Picatinny Rail



Simple and Secure Snap-on  
Installation with Posi-lock Stop  
Bar to Prevent Shifting





# AK STOCK KITS & RECEIVER ADAPTOR

## UTG PRO® AK Mil-spec Collapsible Stock Kits

- End Plate Castle Nut and Mil-spec Receiver Extension Tube (TLU001) Machined from Aircraft Aluminum with a Matte Black Finish
- Mil-Spec 6 Position Stock Constructed from Impact Resistant High Strength Polymer



RBU47KT01  
**With Gen I Standard Stock Height Adaptor**



RBU47KT02  
**With Gen II Elevated Stock Height Adaptor**



RBU47KT03  
**With Gen III Adjustable Stock Height Adaptor**



Complete with AK Stamped Receiver Adaptor with Adjustable Height up to 20mm (RBU47KT03)



TL-K7FAD01

### AK Side Folding Stock Adaptor

- Requires UTG AK Stock Adaptor (TL-A68747-AD1) for Conversion, Compatible with Most 4/6 Position AR15 Stocks and Extension Tubes
- Heavy Duty Steel Construction with a Matte Black Finish
- Increased Flexibility



# AK/SKS ACCESSORIES

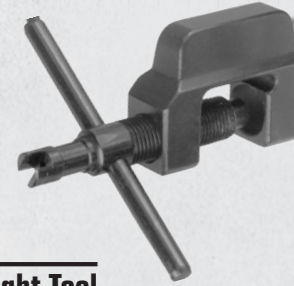

SCP-WEA05

### AK/SKS Front Sight Tool

- An Essential Tool for Making Fine Front Sight Post Windage and Elevation Adjustments
- Compatible with AK, SKS, MAK, and SLR95 Pattern Rifles



Elevation Adjustment



Windage Adjustment



TL-M47SR

### AK Precision Machined Steel Side Plate

- Fits Both Milled and Stamped Receivers and Accepts a Wide Variety of Side Optic Mounts
- Permanent Gunsmithing Required



TL-MGK702

### AK Dual Magazine Clamp

- High Strength Spring Steel Construction with a Matte Black Finish
- Fits Classic 7.62X39mm Magazines

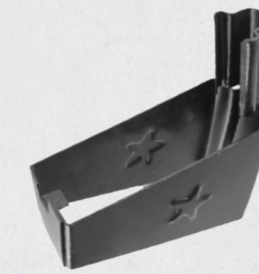
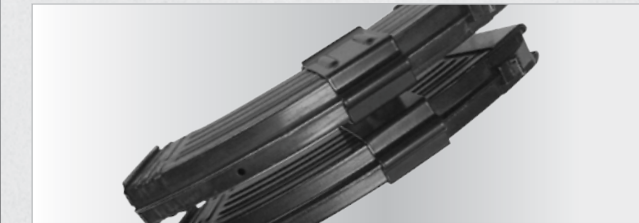

TL-K060

### AK/MAK Speed Loader

- Magazine Loader Fits AK or MAK-90 Magazines
- Speed Loads Using 7.62x39mm Stripper Clips



RB-K7BTP01

### AK Butt Pad

- Ergonomic Slip-on Design with Reinforced Outer Lip
- 1" LOP Extension



RB-TPG478B

### Ergonomic AK Pistol Grip

- Heavy Duty Polymer Construction with Rubberized Overmold
- Ergonomic Trigger Finger Swell Aids in Consistent Placement of Trigger Finger When Firing
- Storage Compartment with Removable End Cap





# QUICK DETACH SLING SWIVEL ADAPTORS & PLATES



BLACK TLUSW001  
FDE TLUSW001D



## UTG PRO® M-LOK® QD Sling Swivel Adaptor

- Precision Machined from 6061-T6 Aircraft Aluminum with a Matte Black Anodization or FDE CERAKOTE®
- Lightweight, Low Profile Design Requires Minimal M-LOK® Rail Space while Retaining Optimum Mount Performance
- Bidirectionally Mounts and Efficiently Utilizes Rail Real Estate by Mounting Either in One Slot or In-between Adjacent Slots on the Same Track
- Accepts Any Standard Quick Detach Sling Swivel with 0.37" Diameter Swivel Stud
- Designed with Quarter Turn Rotational Over Travel Stops to Restrict Swivel Movement and Prevent Sling Tangling



## UTG PRO® Keymod QD Sling Swivel Adaptor

- Precision Machined from 6061-T6 Aircraft Aluminum with a Matte Black Anodization
- Accepts Any Standard Quick Detach Sling Swivel with 0.37" Diameter Swivel Stud
- Designed with Quarter Turn Rotational Over Travel Stops to Restrict Swivel Movement and Prevent Sling Tangling



## Picatinny/Keymod QD Sling Swivel Adaptor

- Innovative, Compact, and Lightweight Design Adaptable for Installation on Both Picatinny or Keymod Rails
- Accepts Any Standard Quick Detach Sling Swivel with 0.37" Diameter Swivel Stud
- Precision Machined from Aircraft Aluminum with a Matte Black Finish

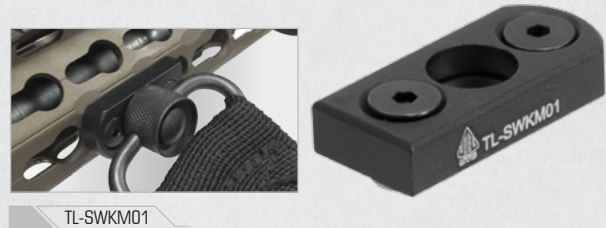

## Keymod QD Sling Swivel Adaptor

- Compact, Lightweight, Super Low Profile Keymod Base
- Accepts Any Standard Quick Detach Sling Swivel with 0.37" Diameter Swivel Stud
- Precision Machined from Aircraft Aluminum with a Matte Black Finish



## Low Profile Angled QD Sling Swivel Picatinny Adaptor

- Accepts Any Standard Quick Detach Sling Swivel with 0.37" Diameter Swivel Stud
- Precision Machined from Aircraft Aluminum with a Matte Black Finish
- Low Profile and Lightweight Design with 45 Degree Offset
- Designed with Quarter-turn Rotational Over Travel Stops to Restrict Swivel Movement and Prevent Sling Tangling



## AR15 QD Receiver End Plate

- Compatible with Standard Mil-spec AR15 Lower Receiver
- Solid Steel Construction with a Matte Black Finish
- Accepts Any Standard Quick Detach Sling Swivel with 0.37" Diameter Swivel Stud
- Designed with Quarter Turn Rotational Over Travel Stops to Restrict Swivel Movement and Prevent Binding Against the Buffer Tube and Sling Tangling

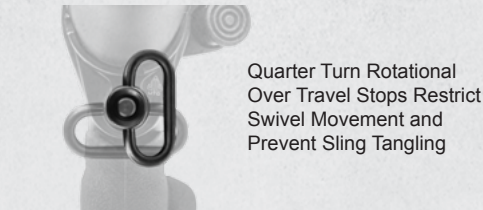

## AR15 Collapsible Stock Receiver End Plate

- Steel Construction with a Matte Black Finish
- Left and Right Sling Loops Accommodate Most Strap and Hook Type Sling Applications
- Compatible with both Mil-spec and Commercial-spec Receiver Extension Tubes



# QUICK DETACH SLING SWIVELS & SLING SWIVEL MOUNT



## Picatinny Sling Swivel Mount with 1.25" Loop

- Precision Machined Aircraft Aluminum and Steel Construction with a Matte Black Finish
- Solid Steel 1.25" Sling Loop Compatible with Most Slings on the Market

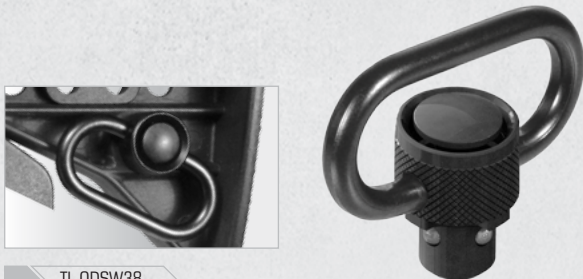
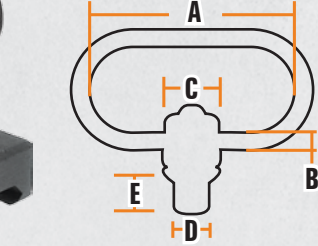
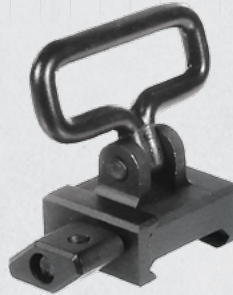

## Heavy Duty Push Button QD Sling Swivel with 1.38" Loop

- High Strength Steel Construction with a Matte Black Finish

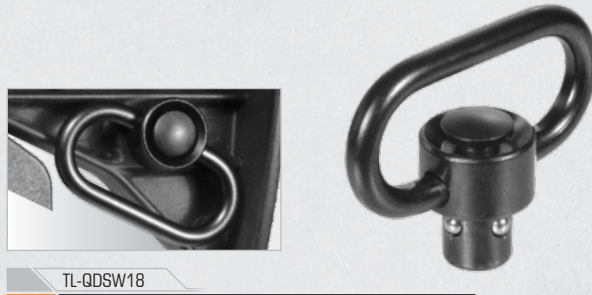

## Standard Push Button QD Sling Swivel with 1.25" Loop

- High Strength Steel Construction with a Matte Black Finish

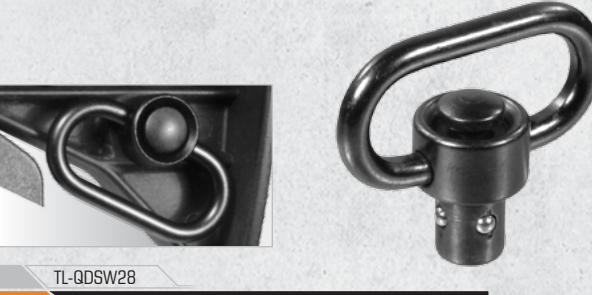

## Heavy Duty Push Button QD Sling Swivel with 1.38" Loop for 4mm Deep Housings

- High Strength Steel Construction with a Matte Black Finish
- Extended Ball Bearing Distance for Optimal Fit with 4mm Deep Housings
- Compatible with the Following UTG® and UTG PRO® Products: MTU001, MTU003, MTU007, MTU015, MTU018, MTU001T, MNT-BR005, MNT-BR101TR-A, MNT-BR002, MNT-BR005XL, and MNT-BR003XL

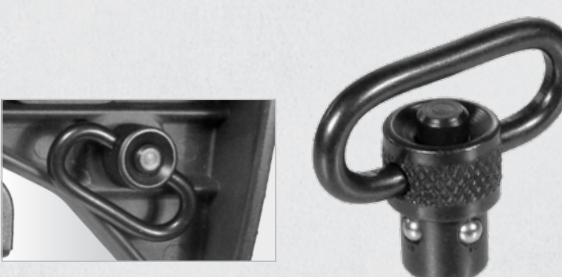

## Standard Push Button QD Sling Swivel with 1.09" Loop

- High Strength Steel Construction with a Matte Black Finish

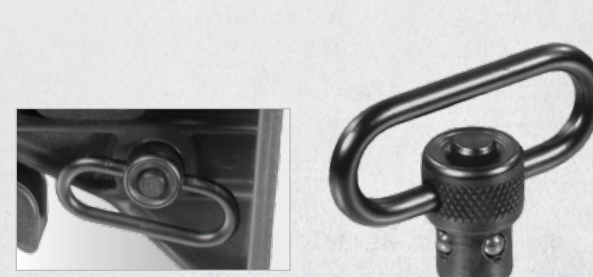

## Standard Push Button QD Sling Swivel with 1.25" Loop

- High Strength Steel Construction with a Matte Black Finish



## Standard Push Button QD Sling Swivel with 1.29" C-Shape Loop

- High Strength Steel Construction with a Matte Black Finish

Item # (Model)	TL-QDSW38	TL-QDSW18	TL-QDSW28	TL-QDSW08A	TL-QDSW08B	TL-QDSW08C
A-Loop Width	1.38"	1.38"	1.38"	1.09"	1.25"	1.29"
B-Loop Thickness	0.18"	0.17"	0.17"	0.13"	0.13"	0.13"
C- Push Button Diameter	0.64"	0.60"	0.17"	0.47"	0.47"	0.47"
D-Stud Diameter	0.37"	0.37"	0.37"	0.37"	0.37"	0.37"
E-Stud Height	0.35"	0.37"	0.47"	0.35"	0.35"	0.35"



**NEW**  
TL-TRM01

**M-LOK® Angled Index Mount**

- Precision Machined from 6061-T6 Aluminum and Finished in a Matte Black Anodization
- Provides an Additional Support Hand Indexing and Retention Point [Also Refer to P.148]



**NEW**  
MT-FGM01

**M-LOK® Super Slim Foregrip**

- Aircraft Aluminum Finished in a Matte Black Anodization
- Removable Red and Blue Anodized Inserts Add a Level of Personalization [Also Refer to P.150]



**NEW**  
MT-AFGM01

**M-LOK® Angled Foregrip**

- 6061-T6 Aluminum Construction Available in Matte Black, Blue, or Red Anodization
- Ergonomic Contour Improves Firearm Handling and Speeds Up Transitions [Also Refer to P.148]

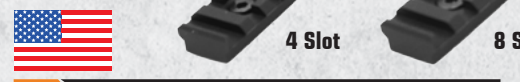

**UTG PRO® M-LOK® Picatinny Rail Sections**

- Precision Machined from 6061-T6 Aircraft Aluminum with a Matte Black Anodization or FDE Cerakote® Finish
- Continuous Rail Edge Design for Optimal Accessory Attachment

Model #	Black	MTURS09S	MTURS09M
Slots		4	8
Other Available Colors		MTURS09SD	MTURS09MD
	D=FDE		

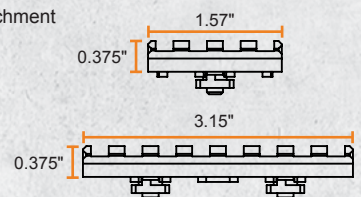

**NEW**  
PATENT PENDING  
HIGH PROFILE TL-BPDM02  
MEDIUM PROFILE TL-BPDM01

**M-LOK® Recon Flex™ Bipod**

- Ergonomic Spring Loaded Slide Locking Ring for Quick and Effortless Bipod Deployment
- Lightweight Aircraft Aluminum Construction with a Matte Black Finish
- Fully Adjustable Legs with Precut Extendable Lengths and Flexible In-between Positions Lockable via Thumb Wheel [Also Refer to P.106]



**NEW**  
TL-HSM01

**M-LOK® Ultra Slim Hand Stop**

- 6061-T6 Aluminum Construction Available in Matte Black, Blue, or Red Anodization
- Ergonomic Contour Improves Firearm Handling and Speeds Up Transitions [Also Refer to P.149]



**NEW**  
RB-HP30M (Set of 4)

**M-LOK® Rail Panel Covers**

- 3.15" in Length, Slim, lightweight, and Securely Installs via Two M-LOK® Screws and Nuts
- Unique Aggressive Nonslip Textured Design Provides a Sure Grip Every Time
- Molded from Durable Impact and High Heat Resistant Polymer with a Rubberized Overmold for Added Grip Traction [Also Refer to P.153]



**IN-HOUSE Cerakote**  
BLACK TLUSW001  
FLAT DARK EARTH TLUSW001D

**UTG PRO® M-LOK® QD Sling Swivel Adaptor**

- Precision Machined from 6061-T6 Aircraft Aluminum with a Matte Black Anodization or FDE Cerakote® Finish
- Lightweight, Low Profile Design Requires Minimal M-LOK® Rail Space while Retaining Optimum Mount Performance [Also Refer to P.156]



RG-FL27MC

**M-LOK® Offset Ring Mount**

- Removable Offset Mount Provides 1.60" Forward or Rearward Offset in addition to the Flashlight Ring's 1.12" Vertical or Downward Offset
- Complete with 2 Spacers to Accept 27mm, 25.4mm (1"), or 20mm Flashlight Tube Diameters [Also Refer to P.59]



**NEW**  
TL-HSK01

**KeyMod Ultra Slim Hand Stop**

- 6061-T6 Aluminum Construction Available in Matte Black, Blue, or Red Anodization
- Ergonomic Contour Improves Firearm Handling and Speeds Up Transitions [Also Refer to P.149]

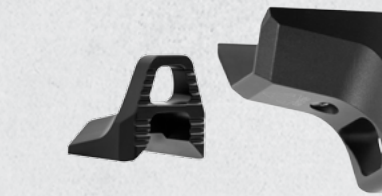

TL-HS02B

**KeyMod Hand Stop/Barricade Rest Kit**

- Promotes Proper Support Hand Memory Placement and Retention [Also Refer to P.149]



**UTG PRO® KeyMod Picatinny Rail Sections**

- Precision Machined from 6061-T6 Aircraft Aluminum with a Matte Black Anodization or Cerakote® Finish
- Continuous Rail Edge Design for Optimal Accessory Attachment

Model #	Black	MTURS04S	MTURS04M
Slots		4	8
Other Available Colors		MTURS04SD	MTURS04MD
	D=FDE	MTURS04SG	MTURS04MG
	G=OD Green	MTURS04SM	MTURS04MM
	M=Gun Metal	MTURS04SZ	MTURS04MZ
	Z=Burnt Bronze		



**NEW**  
MT-AFGK01

**KeyMod Angled Foregrip**

- 6061-T6 Aluminum Construction Available in Matte Black, Blue, or Red Anodization
- Ergonomic Contour Improves Firearm Handling and Speeds Up Transitions [Also Refer to P.148]



**NEW**  
TL-TRK01

**KeyMod Angled Index Mount**

- Precision Machined from 6061-T6 Aluminum and Finished in a Matte Black Anodization
- Provides an Additional Support Hand Indexing and Retention Point [Also Refer to P.148]



**NEW**  
MT-FGK01

**KeyMod Super Slim Foregrip**

- Aircraft Aluminum Finished in a Matte Black Anodization
- Removable Red and Blue Anodized Inserts Add a Level of Personalization [Also Refer to P.148]



**NEW**  
PATENT PENDING  
HIGH PROFILE TL-BPDK02  
MEDIUM PROFILE TL-BPDK01

**KeyMod Recon Flex™ Bipod**

- Ergonomic Spring Loaded Slide Locking Ring for Quick and Effortless Bipod Deployment
- Fully Adjustable Legs with Precut Extendable Lengths and Flexible In-between Positions Lockable via Thumb Wheel [Also Refer to P.106]

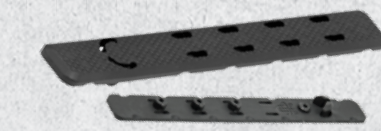

RB-HP25B (Set of 7)

**Low Profile KeyMod Rail Panel Covers**

- Molded from Durable Impact Resistant Polymer
- 5.5" in Length, Slim, Lightweight, and Securely Fits into Standard KeyMod Rail Slots [Also Refer to P.153]



TLUSW002

**UTG PRO® KeyMod QD Sling Swivel Adaptor**

- Precision Machined from 6061-T6 Aircraft Aluminum with a Matte Black Anodization or FDE Cerakote® Finish
- Low Profile, Lightweight, and Compact Design
- Bidirectionally Mounts to Most KeyMod Mounting Platforms [Also Refer to P.156]

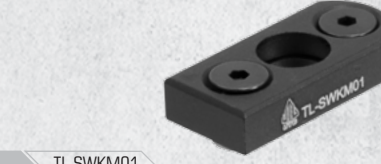

TL-SWKM01

**KeyMod QD Sling Swivel Adaptor**

- Precision Machined from Aircraft Aluminum with a Matte Black Finish [Also Refer to P.156]



RG-FL27KC

**KeyMod Offset Low Profile Ring Mount**

- Removable Offset Mount Provides 1.60" Forward or Rearward Offset in addition to the Flashlight Ring's 1.12" Vertical or Downward Offset
- Complete with 2 Spacers to Accept 27mm, 25.4mm (1"), or 20mm Flashlight Tube Diameters [Also Refer to P.59]





# BROKEN SHELL EXTRACTORS & OTHER ACCESSORIES



TL-EX223  
**.223/5.56 Broken Shell Extractor**

TL-S001  
**7.62X39 Broken Shell Extractor**

TL-EX308  
**.308 Broken Shell Extractor**



## Broken Shell Extractor

- Removes Broken Shell Casings from a Jammed Chamber
- Threaded Two-piece Design to Adjust Overall Length, Compatible with Bolt Action and Semi-automatic Rifles
- Precision Machined from Steel
- Keep One with Your Shooting Gear, in Your Tool Kit, or Gun Case



TL-GLK01  
**California DOJ Approved Firearm Cable Lock**

- Certified by California Department of Justice
- Universal Design Compatible with Most Long Guns and Pistols
- Locking Cable is 0.21"(5.3mm) in Diameter and 15"(381mm) in Length
- Plastic Wrap Prevents Cable from Scratching Firearm Finishes

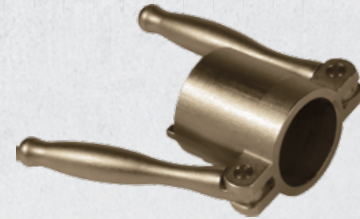

TL-SHWR01  
**Universal Shotgun Forend Wrench**

- Nickel Plated Steel Construction
- User Friendly with Ergonomic Handles for Easy Forend Removal and Installation
- Compatible with Remington® 870™, Mossberg® 500A/C, 835, and Other Clones



RB-CSF06  
**Chamber Safety Flag**

- Bright Orange for High Visibility and Reliable Confirmation of an Unloaded Firearm
- Molded from Impact Resistant Polymer with Reinforced Head for Maximum Durability
- Ideal for Cold Range Use and Mass Produced Firearms



RB-A005  
**AR15 Receiver Wedge**

- Snugly Fits Behind Rear Take Down Pin
- Keeps the Upper Snug and Tight Against the Lower
- Prevents Upper and Lower Receiver Rattle



Reliably Proven and Exceeds MILITARY STANDARDS with Tens of Thousands Sold

MNT-16AD1-C  
**For AR15 Rifle**

MNT-16AD2-C  
**For AR15 Carbine**

## AR15 Blank Firing Adaptor

- Precision Machined High Strength Steel Construction
- Color Coated for Protection and Discernibility
- Reinforced Frame Surpasses Military Standards
- Ideal for Law Enforcement and Military Training
- User Friendly Bolt Ring for Simple Installation and Removal



# CLEANING KITS



TL-A041  
**.223/5.56mm Cleaning Kit**

- Includes a 5-piece Extension Steel Cleaning Rod with Adaptor, Patch Loop, Bronze Bore Brush, Chamber Brush, Double-Ended Nylon Utility Brush, ½ oz Oil Bottle, and Cleaning Patches
- All Parts Conveniently Store within the Included OD Green Nylon Pouch with Belt Loop and ALICE Clip Attachment Point and Featuring Two Hook-and-loop Closure Pockets and External Snap Button Flap



TL-CLP9MMKT  
**9mm Pistol Cleaning Kit**

- Conveniently Stows Away in Any Range Bag in Its Compact Polymer Case (4.63"x2.88"x1.50")
- Kit Includes an 8-32 Threaded Copper Alloy Cleaning Rod with the Following Threaded Cleaning Accessories: Patch Loop, Bronze and Nylon Brush, and a Cotton Mop



PVC-CLMAT01  
**Universal Firearm Cleaning Mat**

- 14.75"x52" Universal Firearm Cleaning Mat with Nonslip Rubberized Backing
- 4" Wide Side Pocket with Zipper Closure for Cleaning Tools and Small Parts
- Durable Solvent and Chemical Resistant Material for Long Lasting Performance [Also Refer to P.191]